

Article number: 20058511

Description: E+G Quick-fit coupling (radial displacement)
GN 240.2-M10

Measures

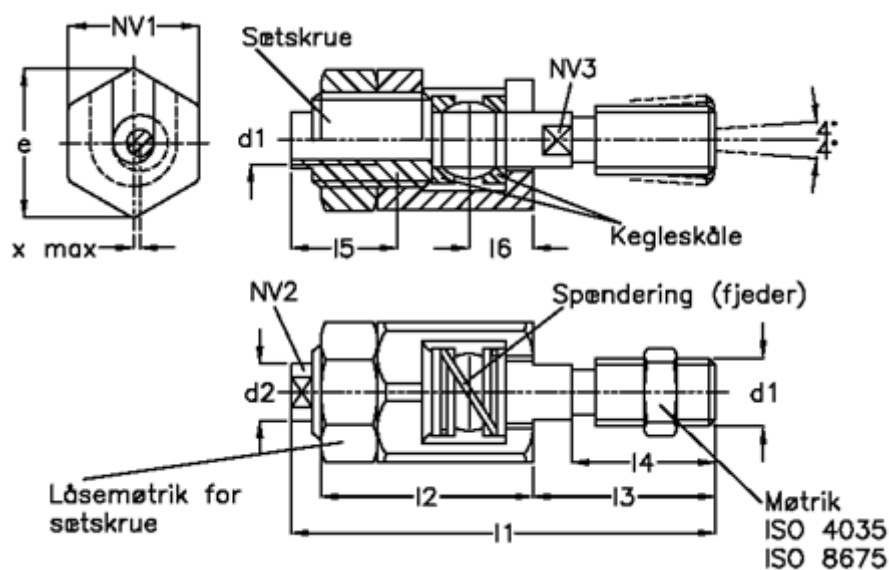

d1 = M 10x1,5	l6	= 16.0
d2 = 21.0	Max displacement	= 0.7
e = 44.0	Max push-pull strength N	= 6500
l1 = 81	NV 1	= 41
l2 = 43	NV 2	= 18
l3 = 30.5	NV 3	= 12
l4 = 22		
l5 = 24		